

DRILLING OF GLACIER BOREHOLES WITH A HYDROPHILIC LIQUID

V. S. ZAGORODNOV¹, J. J. KELLEY¹ and O. V. NAGORNOV²¹*Polar Ice Coring Office, University of Alaska Fairbanks, Fairbanks, Alaska 99775-1710, U. S. A.*²*Moscow Engineering Physics Institute, 31 Kashirskoe Shosse,
Moscow 115409, Russia*

Abstract: During the last twenty years over 10000 m of ice core have been recovered through the use of antifreeze thermal electric drills (ATED). An environmentally safe ethanol-water solution (EWS) was utilized as a borehole liquid. The ATED method has been widely used on high mountain temperate and polar glaciers. At glacier temperatures (T_i) from -28 to -8°C the ATED penetration rate is about 420–450 m/wk (I. A. ZOTIKOV; CRREL Rep., 79-24, 12 p., 1979; V. S. ZAGORODNOV; Ice Core Drilling: Proc. 3rd Int. Workshop Ice Drilling Tech., 97, 1989). In Antarctica a borehole of 800 m depth was drilled in ice at $T_i = -53^\circ\text{C}$ in two month. Drilling of this borehole was continued the next field season.

The major cause of ice core fracture under thermal drilling is thermoelastic stresses. The quality of an ice core taken under ATED can be significantly improved applying the forced circulation of EWS at the borehole kerf. Experimental and theoretical studies demonstrate that a modified ATED (m-ATED) reduces power consumption by 20%–40%. The penetration rate of the m-ATED at low temperatures (below -30°C) is estimated to be about 450 m/wk. The logistic cost for deep (>1000 m) drilling with ATED is estimated to be about 25% of the conventional thermal or mechanical drilling.

Laboratory experiments show that ice can be dissolved by EWS. The phenomenon of ice dissolution by EWS can underlie the dissolution drilling technology (DDT). Further development of DDT technology may offer: simple drill structure, low power consumption, low thermal effect on ice core and borehole wall, ability to penetrate dirty ice, and low logistic cost.

1. Introduction

For the last twenty years antifreeze thermal electrical drills (ATED) have been used for drilling deep holes in temperate and polar glaciers (KOROTKEVICH *et al.*, 1979; MOREV *et al.*, 1989; ZOTIKOV, 1979;). Ethanol-water solutions (EWS) have been utilized for filling boreholes at temperature of ice (T_i) ranges from 0 to -58°C . Seven boreholes of 110 to 568 m depth were drilled at Svalbard (ZAGORODNOV, 1988). At Severnaya Zemlya one of six boreholes reached the ice cap bottom at a slant depth of 720 m. In Central Antarctica (Dome B) the drilling was carried out up to 780 m depth in seven weeks at a temperature of about -58°C . At Komsomolskaya Station (Antarctica) when the borehole reached 800.6 m depth the drilling stopped. Eleven months later the drilling operation was resumed without any difficulties (MOREV *et al.*, 1989). The Antifreeze Thermal Electrical Drills (ATED) have the following advantages:

- environmental and personal safety;
- penetration rate of 420 m/wk (24 hr shift, 500 m depth, $T_i = -15^\circ\text{C}$);
- directional drilling capability (ZAGORODNOV *et al.*, 1992);
- simple structure, short length, and small shelter;

- low requirement of the drilling liquid (from 5 to 75% of borehole volume);
- the two last-named characteristics provide a significant reduction in the logistical cost.

However, when thermal drilling has been performed at glaciers with the temperature below -25°C the following drawbacks of ATED were exhibited:

- ice core fractionation;
- low speed (0.2–0.3 m/s) of the drill during lowering and raising;
- slush formation;
- ATED has a limited capability to penetrate a dirty ice (regardless of temperature);
- ethanol penetrates the core on depth of 2–3 cm.

In the present paper, technical aspects of ethanol thermal drilling technology considered, the possible modifications of the ATED are suggested. The drilling head and core barrel are subjected to major modification. The principle of the thermal dissolution drilling is also discussed.

2. Ice Core Fracture

It is known that thermal drilling is accompanied by ice core fracture. Sometimes only small pieces of shattered ice core are recovered from a drill. Typically horizontal cracks are formed. At a temperature below -25°C a typical distance between cracks is about 3 mm, at $T_i = -14^{\circ}\text{C}$ the distance is from 10 to 50 cm (NAKAWO and NARITA, 1985; ZAGORODNOV, 1989). In order to improve the quality of the ice core the thermal stresses in an ice core under impact of heater-bit have been examined (NAGORNOV *et al.*, 1994).

The strength of a polycrystalline ice depends on several factors. There are mode of loading, strain rate, grain size, temperature, orientation of *C*-axis, concentration of air bubbles and solid inclusions, etc. The experimental data (ANDREWS, 1985; COLE, 1987; GOLD, 1977; SABOL and SCHULSON, 1989; SCHULSON *et al.*, 1989a, b; TIMCO and FREDERKING, 1982) stated that typical glacier ice (grain size 1 to 10 mm) at common temperature conditions (0 to -60°C) under strain rates higher than $2 \cdot 10^{-2} \text{ s}^{-1}$ has a tensile strength of 1 to 2 MPa and compressive strength of 3 to 4 MPa. The strength of artificial ice under thermal shock was found to be between 3 and 4 MPa (GOLD, 1963).

A schematic of the ATED drill is shown in Fig. 1. Due to its contact with the heating-bit and meltwater at borehole kerf an ice core is subjected to heating. Measured temperature profiles in an ice core during ATED activity are presented in Fig. 2. During the first 500–600 s the ice core is heated considerably, then it is chilled. It was found out experimentally that the drilling fluid transfers the heat to the ice core in 600 s. Thermoelastic stresses in the ice core arise resulting from the thermal expansion of an ice (NAGORNOV *et al.*, 1994). Measured temperature distribution in an ice core during the drilling process indicates an axial stress to be a major factor of formation of horizontal cracks in an ice core. An axial stress in an ice core under impact of the ATED drilling bit as a function of radius is shown in Fig. 3. Clearly the value of axial stress exceeds the tensile and compressive strength of the ice through the ice core radius.

To reduce a thermostress in an ice core it is necessary to decrease the efficiency of the heat transfer between the drilling fluid and the ice core. During the drilling procedure this can be accomplished by a forced circulation of the hydrophilic drilling fluid at the kerf. A

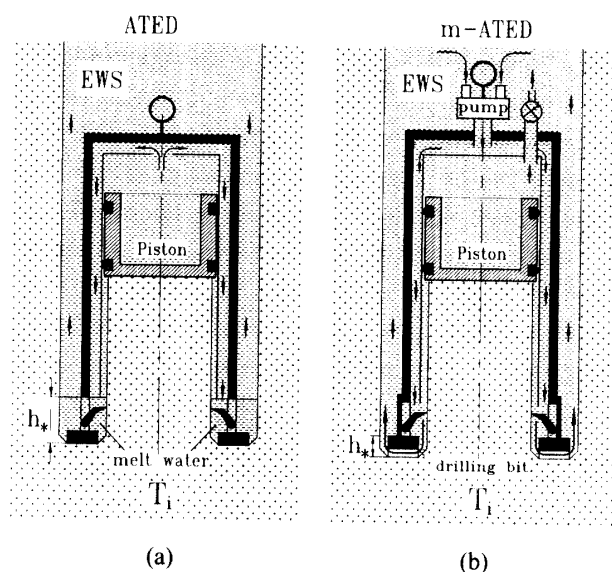

Fig. 1. Schematic of the thermal drills: (a) antifreeze thermal electrical drill (ATED), and (b) modified ATED.

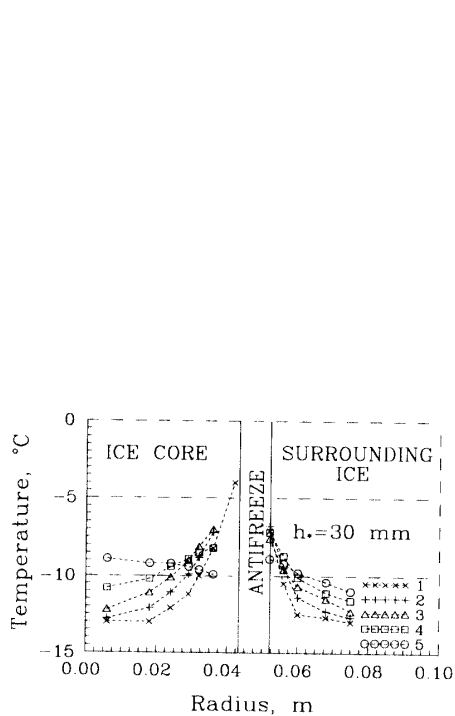

Fig. 2. Temperature distribution in the ice core during ATED drilling; 1-5: $t=10, 40, 80, 120,$ and 440 s.

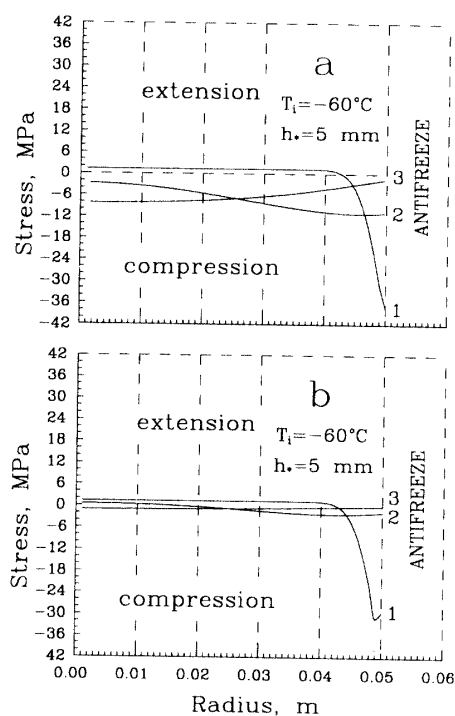

Fig. 3. Maximum axial stress in an ice core during (a) ATED and (b) m-ATED drilling (1-3: $t=5, 310$ and 605 s).

schematic of a modified ATED (m-ATED) is shown in Fig. 1b. In order to obtain maximum heat removal the core catcher's windows should be closed. Then the drilling fluid will be pumped to the borehole kerf at a temperature close to T_i . Homogeneity of the drilling fluid flow at the kerf can be ensured by radial grooves at the bottom of the drilling bit. Thus the cold drilling fluid will be flushed continuously. Which enables the

temperature of the EWS at the kerf zone to be close to T_i .

Thermal coring with a forced EWS circulation under the coldest conditions typical for the Central Antarctica has been modeled. The model simulated axial stress in the ice core is shown in Fig. 3b. A stress decreases by 5 to 6 times in the central portion of the ice core as compared to conventional ATED. At a subsurface layer of the ice core the value of the thermal stress follows the tensile strength of the ice. Therefore the m-ATED makes it possible to obtain a good quality ice core. Another expected advantage of the m-ATED is its capability to penetrate dirty ice. The continuous circulation of EWS will remove the fine solid material from the kerf and provide good heat transfer between the drilling head and ice. For more experimental and theoretical details see NAGORNOV *et al.* (1994).

3. The Lowering of a Drill in a Borehole Filled with Viscous Liquid

The viscosity of the EWS is significantly higher than the other drilling liquids (ZAGORODNOV *et al.*, 1993). Nevertheless the lowering rate of the ATED is about 0.4 m/s and 0.2 m/s at glaciers temperatures -28°C and -53°C respectively (ZOTIKOV, 1979; ZAGORODNOV *et al.*, 1993). To obtain a higher penetration rate of the ATED at temperatures below -30°C its lowering rate should be increased. For better visualization of the ATED structural modifications the following equation has been used (ONISHIN *et al.*, 1990):

$$V = \frac{[(l + r_a^2) \ln l / r_a - (l - r_a^2)] r_2^2 (p_2 - g\rho_1 l)}{4\mu l},$$

where V is the drill's lowering speed, $r_a = r_1/r_2$ is ratio of instrument (r_1) and borehole (r_2) radii, $p_2 = mg/\pi r_1^2$, where m is the instrument mass, g is gravity acceleration, l is the length of instrument, ρ_1 and μ are density and absolute viscosity of the borehole liquid respectively. This formula was developed for estimations of the lowering speed of demountable instruments in industrial boreholes. In the case of the ATED the calculated and experimental data are in good agreement. The dependencies of the lowering rate on T_i , clearance, weight and length of the drill in Figs. 4 and 5 have been calculated by eq. (1). It follows from Figs. 4 and 5 that even at a temperature of -60°C an appropriate lowering speed (0.5 to 0.7 m/s) can be achieved at quite realistic parameters of the m-ATED (Table 1).

The slush formation in deep boreholes at low temperatures is caused by energy loss during lowering and raising of the drilling instrument (ZAGORODNOV *et al.*, 1993). The above modification of the ATED allows for significant reduction of the hydraulic resistance of the drill and the energy loss. Which results in a diminishing of ice slush formation.

Focusing on a design of a new drill, let us consider the conventional ATED and further modification (Fig. 6). If the outer tube of the ATED will be replaced by a few small diameter pipes or channels then the drill-borehole clearance can be expanded by about 80%. This effort provides an increase in a lowering rate up to 0.7 m/s. The optimum parameters of the new drill can be determined based on the above formula. Local hydraulic resistance arising in the drilling bit can be essentially decreased by the windows

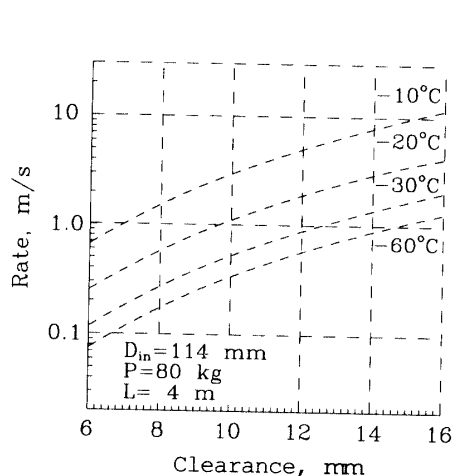

Fig. 4. Dependencies of the drill lowering rate on a clearance between drill and borehole wall.

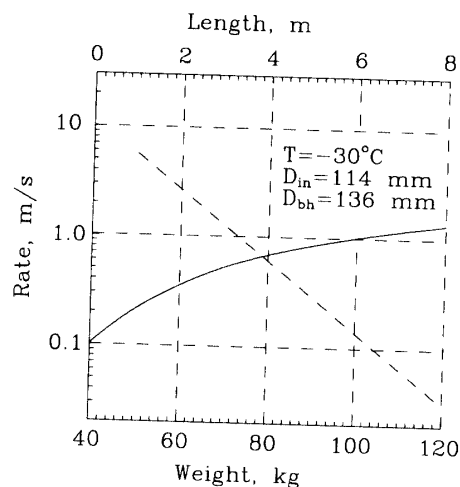

Fig. 5. Dependencies of the lowering rate on the drill's length (dashed line) and its weight (solid line).

Table 1. Parameters of the ATED and m-ATED drills.

Parameter	ATED	m-ATED	
Temperature of ice (°C)	0 ~ -33	0 ~ -60	0 ~ -60
Drilling head diameter (inner/outer, mm)	84/108	105/114	82/100
Borehole diameter (mm)	118	134	110
Ice core diameter (mm)	78-80	101-103	78-80
Drill length (m)	1.8-3.2	4	4
Ice core length (m)	1.5-2.7	3	3
Drill weight (kg)	25-60	80	60
Power consumption (kW)	3-4	3-4	1.5-3
Drilling rate (m/hr)	4	4	4
Penetration rate (m/wk)	420-450	420-450	420-450

located below the core catcher mechanism (Fig. 6b). During lowering and raising of the m-ATED the EWS will pass through the windows. To provide the regime of forced EWS circulation mentioned above the windows should be closed during a drilling action. There are several design solutions for activating the window closing mechanism (stopper); one of them is shown in Fig. 6b. The bottom portion of drilling head is mobile. During the lowering and raising operation three springs press the bottom flange down, keeping the windows open. When the drill reaches the kerf the force of gravity will compress the springs and the windows will be closed. The parameters of the prototype and modified ATED are presented in Table 1.

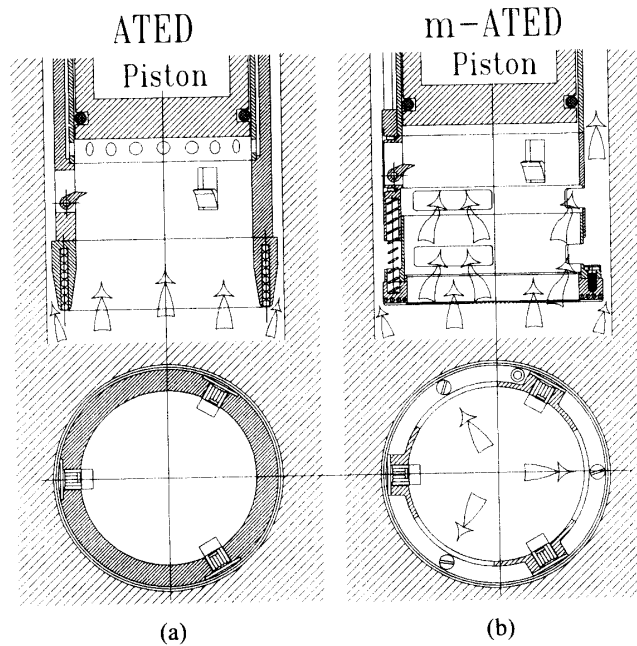

Fig. 6. Schematic of the drilling liquid flow during lowering of the ATED and m-ATED into borehole.

4. Parameters of EWS in Glacier Borehole

The concentration (C_{eq}), density (ρ_e) and kinematic viscosity (ν) of the EWS depend on the temperature (T) (MOREV and YAKOVLEV, 1984). These experimental parameters as functions of a temperature can be approximated by the following temperature dependencies:

$$C_{eq}(T) = 0.01454 \cdot T,$$

$$\rho_e = 999.187 + 4.72394 \cdot T + 0.30828 \cdot T^2 + 0.008421 \cdot T^3 + 7.05243 \cdot 10^{-5} \cdot T^4, \text{ (kg} \cdot \text{m}^{-3}\text{)}$$

$$\nu = 2.10911 + 1.05558 \cdot T + 0.20863 \cdot T^2 + 0.004692 \cdot T^3 + 3.14625 \cdot 10^{-5} \cdot T^4. \text{ (cSt)}$$

If the temperature profile $T(z)$ is known, then the C_{eq} , ρ_e and ν as functions of depth (z) in the glacier can be calculated.

To obtain the pressure of EWS in the borehole $p_e(z)$ and the ice-overburden pressure $p_h(z)$ the ice density profile $\rho_i(z)$ and level of EWS in the borehole H should be known. Then the pressure difference between EWS and ice-overburden pressure $\Delta p = p_e(z) - p_h(z)$ can be found:

$$p_e(z) = \begin{cases} 0, & z < H \\ g \int_H^z \rho_e(T(z)) dz, & z > H \end{cases} \quad (1)$$

$$p_h(z) = g \int_0^z \rho_i(z) dz, \quad (2)$$

$$\Delta p(z) = g \int_0^z [\rho_i(z) - \rho_e(T(z))] dz. \quad (3)$$

For example the conditions of the Byrd Station hypothetical borehole ($H=75$ m) was considered. Calculated $C_{eq}(z)$, $\rho_e(z)$ and $\Delta p(z)$ profiles in a hypothetical borehole are shown in Figs. 7 and 8. The average concentration of EWS in the borehole is close to 32%. To fill-in the 134 mm in diameter borehole 9 t of 95% ethanol is necessary. Approximately one more ton of ethanol will be needed for slush dissolution (ZAGORODNOV *et al.*, 1993). With small diameter m-ATED only 7.4 t will be required. For comparison approximately 56.8 t of DFA and trichlorethylene were consumed for drilling borehole of 2164 m depth at Byrd Station.

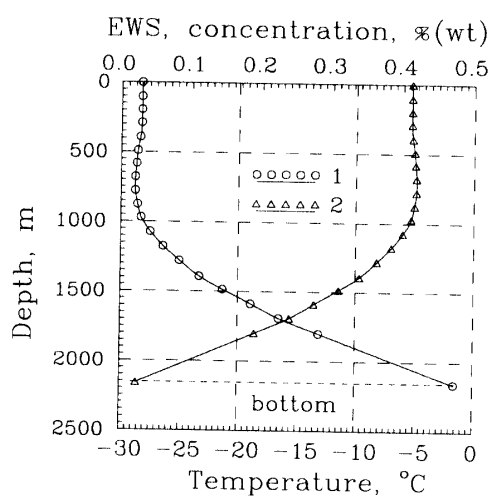

Fig. 7. Temperature (1) and concentration (2) of EWS in a hypothetical borehole.

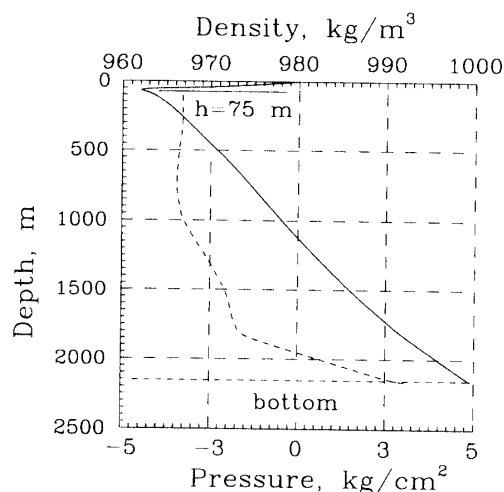

Fig. 8. Density of EWS (dashed line) and pressure difference (solid line) between EWS and ice-overburden pressure in a hypothetical borehole; H is level of EWS in the borehole.

The calculated density of EWS through the borehole depth is greater than that of an ice (Gow, 1970). In such conditions the ice-overburden pressure at the top of the borehole exceeds slightly (5 bars) the EWS pressure. At the bottom the opposite situation takes place. The compensation of the ice-overburden pressure provided by EWS is not less than that by DFA-trichlorethylene solution. We came to the conclusion that the application of the EWS with m-ATED can be used for deep drilling of the West Antarctica Ice Sheet.

5. Thermal Dissolution Drilling

It is well known the ethanol dissolves an ice. Obviously this phenomenon can benefit for the penetration into the glaciers. The schematic of a thermal dissolution drill (TDD) is shown in Fig. 9. This drill consists of a pump, a core barrel, a drilling bit and injector. The pump provides a circulation of a hydrophilic drilling liquid. The drilling liquid heats up when it passes through the drilling bit. The schematic of the drill is similar to "self-

flushing hot-water drill" (SFHWD) developed by RADO *et al.* (1987). The SFHWD drill melts the ice by consuming the electric power while the TDD consumes the electric power and the potential energy of the solvent. Obviously the drilling head with EWS injection can be designed for ice coring. The schematic of the TDD does not differ much from that of m-ATED. The drilling head should be modified.

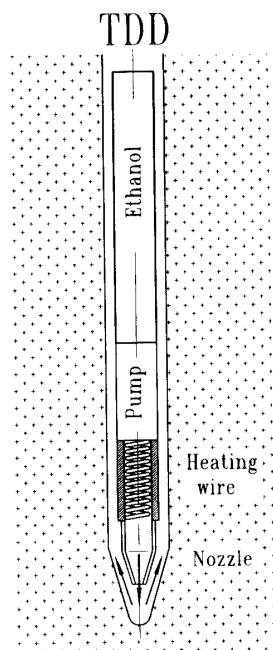

Fig. 9. Schematic of the thermal dissolution drill (TDD).

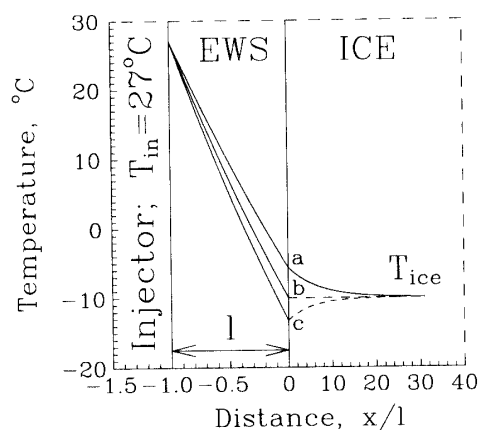

Fig. 10. Temperature distribution during one-dimension steady state ice-EWS dissolution: a - $C_{in} = 0.300$, b - $C_{in} = 0.647$, c - $C_{in} = 1.0$.

The experimental and theoretical investigations have been performed to realize this principle. The parameters of an endothermic ice-EWS dissolution reaction have been determined by calorimeter (NAGORNOV *et al.*, 1994). It is an endothermic reaction. We found experimentally that the latent heat of ice dissolution by ethanol varied from 300 kJ/kg at temperature -2°C to the value of 100 kJ/kg at -24°C .

The inputs of the mathematical model of TDD were selected based on experimental parameters of the ice-EWS interaction. The most attractive result of modeling is shown in Fig. 10. Under specific conditions the TDD drill may provide a three temperature regimes of the ice: (1) the ice heating, (2) invariable stage and (3) the ice cooling. The last-named regime allows for the recovery of an ice core which is not subjected to heating. When the ice temperature is -3°C the expected rate of the drilling-dissolution is 2.7 times higher than a speed of the drilling-melting.

The next promising result of the modeling consists in a low power consumption of TDD. In a temperate glacier ($T_i = -3^{\circ}\text{C}$) at a dissolution drilling rate of 10 m/hr a 0.1 m diameter borehole can be drilled by consuming 80 W of electrical power and 25 g/s of ethanol. In this case the model demonstrates a large potential power saving. At a temperature of -20°C , the reduction of the power consumption is about 30%. Further

physical and mathematical modeling are able to find an optimal proportion of the power and ethanol consumption. Probably, in some cases, to dissolve the ice by ethanol is preferable to burning oil by a power generator appears to be more efficient. Development of a practical dissolution drilling technology is the subject for further research.

6. Discussion

The proposed parameters of the drilling operation (2200 m) in the West Antarctic Ice Sheet ($T_i = -28^\circ\text{C}$) derived from calculations are shown in Table 2. The calculations were specified based on both the m-ATED estimated parameters (Table 1) and field experience. Due to a small drilling fluid requirements and portable drilling equipment the total weight of transported cargo is about 20 t. Only four drilling specialists are needed to operate the m-ATED during two of 12 hours shifts. The heaviest part of equipment is the winch (500 kg). Because the penetration rate of the m-ATED is about 450 m/wk and short time is needed for mounting and disassembling the camp and drilling equipment the field operation can be fulfilled in 8–10 weeks.

Table 2. Estimated weight (t) of the drilling equipment, superstructure and camp equipment for drilling of the 2200 m deep borehole in West Antarctica ($T_i = -28^\circ\text{C}$, m-ATED drill, field staff - 6 person).

Shelters (weather port, tents)	2.5
Diesel generator (8 kW)	0.4
Winch (2200 m, 4 kW)	0.5
Cable (Kevlar, 2200 m)	0.4
m-ATED drill	0.1
Control box, power cables	0.2
Hand tools, spears and accessories	0.4
Ethanol (200-l drums)	10.0 (7.4)
DFA (200-l drums)	1.6
Camp equipment	1.4
Food	2.0
Total weight	19.2 (16.2)

Numbers in brackets are estimated for m-ATED with ice core and borehole diameters 80 and 110 mm, respectively.

7. Conclusions

The drawbacks of the antifreeze thermal drilling technology (ice core fractionation, low speed of lowering, slush formation, limited capability to penetrate a dirty ice) can be overcome by modification of the conventional ATED drill.

The forced circulation of the drilling fluid (EWS) at the kerf decreases the ice core heating. The longitudinal component of the thermal stress in the ice core will be reduced 5 to 6 times as compared with the conventional ATED. The quality of the ice core obtained by m-ATED will be significantly higher. Forced circulation of EWS at the borehole kerf

increases the m-ATED drills capability to penetrate dirty ice.

The structure of the ATED makes it possible to expand the drill-borehole clearance by about 80%. The local hydraulic resistance of the drilling head can be diminished by windows with a mobile stopper. These improvements provide a lowering rate of about 0.5–0.7 m/s at temperature -60°C , resulting in a drilling rate of 350–420 m/week. Thermal-dissolution appears to be favorable for ice penetration. The TD drill will combine all advantages of the m-ATED mentioned above with potential for low power consumption.

The application of the modified ATED and EWS makes it possible to drill a 2200-m deep borehole in the West Antarctic Ice Sheet in one field season. The total weight of the drilling equipment, drilling liquid, shelters including camping equipment and food are estimated as 20 t.

Acknowledgments

This research was supported by Russian Academy of Science and U.S. National Science Foundation as part of the Program of U.S.-USSR Cooperation in the Field of Basic Scientific Research. Authors wish to thank Bruce KOCI for constructive and valuable discussion of ATED modifications. The authors thank Laurent AUGUSTIN for valuable comments and suggestions. We are grateful to our colleagues from the Polar Ice Coring Office and the faculty of the University of Alaska Fairbanks, and to the Institute of Marine Science Publications Office for their assistance with editing and preparing this manuscript for publication.

Appendix

After presentation of the paper at the Workshop a short model (48 cm length and 109 mm diameter) of the m-ATED has been constructed and tested in the laboratory ($T_i = -13^{\circ}\text{C}$). The experiment was conducted by using an experimental stand, which permit to monitor penetration rate and temperature of the ice and EWS drilling fluid (Fig. 11). A similar stand was described by NAGORNOV *et al.* (1994). The major goal of this experiment was penetration of sandy ice. For that purpose a cube of ice 23 cm an edge incorporated a 7 cm thick horizontal layer of frozen sand with a 60–70% volume concentration. The drilling was fulfilled using about 75% power capacity of the drilling bit. The drill moved through the ice at a rate of 1 mm/s (3.6 m/hr) in the upper portion of the block ice (clear). In the frozen sand layer and bottom portion of the ice block (also clear ice) it moved at a rate of 0.5 mm/s.

The diameter of the ice core (Fig. 12), obtained during this experiment, was 6–15 mm less than that taken during penetration of uncontaminated ice block. This is explained that by the slow penetration and conductive heating, respectively, melting the core above the drilling head. However, the diameter of the core of the sandy ice is not significantly smaller the rest of the core.

The experiment shows that forced circulation of the drilling fluid (EWS) make it possible to core extremely sandy ice. To improve the capability of the m-ATED for penetration of a thick ice-sand composite the solid material (sand and rock fragments)



Fig. 11. The experimental stand.

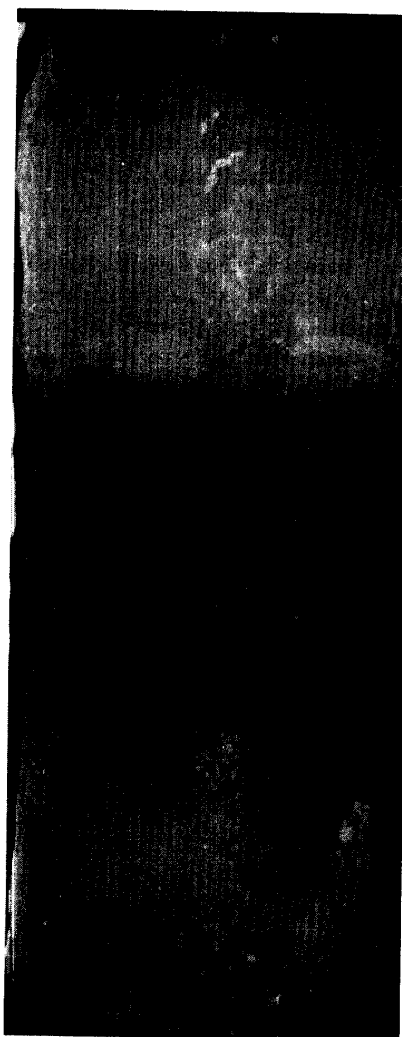

Fig. 12. The ice core taken by *m-ATED* (the core length is about 21 cm).

should be removed from the kerf constantly. This modification, will increase the penetration rate of the sandy ice.

References

- ANDREWS, R.M. (1985): Measurement of the fracture toughness of glacier ice. *J. Glaciol.*, **31**, 171-176.
- COLE, D.M. (1987): Strain-rate and grain-size effects in ice. *J. Glaciol.*, **33**, 274-280.
- GOLD, L.W. (1963): Crack formation in ice plates by thermal shock. *Can. J. Phys.*, **41**, 1712-1728.
- GOLD, L.W. (1977): Engineering properties of fresh-water ice. *J. Glaciol.*, **19**, 197-212.
- GOW, A.J. (1970): Preliminary results of studies of ice cores from the 2164 m deep drill hole, Byrd Station, Antarctica. International Symposium on Antarctic Glaciological Exploration (ISAGE), ed. by A. G. Gow *et al.* Cambridge, SCAR, 78-90 (Publication. No. 86).
- KOROTKEVICH, E.S., SAVATIUGIN, L.M. and MOREV, V.A. (1979): Trough drilling a shelf glacier in the region of Novolazarev Station. WDC No. 81001417, CRREL No. 35001057 (Inf. Buill. Sov. Antarct. Eksped., **98**).
- MOREV, V.A. and YAKOVLEV, V.M. (1984): Liquid fillers for bore holes in glaciers. CRREL Spec. Rep., **84-34**, 133-135.
- MOREV, V.A., MANEVSKIY, L.M., YAKOVLEV, V.M. and ZAGORODNOV, V.S. (1989): Drilling with ethanol-based antifreeze in Antarctic. Ice Core Drilling; Proceedings of the Third International Workshop on Ice Drilling

- Technology, Grenoble, France, Oct. 10–14, 1988, ed. by C. RADO and D. BEAUDOING. Grenoble, Centre National de la Recherche Scientifique, Laboratoire de Glaciologie et Geophysique de l'Environnement, 110–113.
- NAGORNOV, O.V., ZAGORODNOV, V.S. and KELLEY, J.J. (1994): Effect of a heated drilling bit and borehole liquid on thermoelastic stresses in an ice core. *Mem. Natl Inst. Polar Res., Spec. Issue*, **49**, 314–326.
- NAKAWO, M. and NARITA, H. (1985): Density profile of a 413.5 m deep fresh core recovered at Mizuho Station, East Antarctica. *Mem. Natl. Inst. Polar Res., Spec. Issue*, **39**, 141–156.
- ONISHIN, V.P., BLINOV, G.A., VARTIKAYN, B.G. and PLAVSKII, D.N. (1990): *Metody, tekhnologii i organizatsiy burovikh robot s ispolzovaniem c'emnogo instrumenta* (Methods, technology and logistic of the drilling operations using a demountable instruments). Leningrad, Nedra, 268 p.
- RADO, C., GIRARD, C. and PERRIN, J. (1987): Electrochaude: a self-flashing hot-water drilling apparatus for glaciers with debris. *J. Glaciol.*, **33**, 236–238.
- SABOL, S.A. and SCHULSON, E.M. (1989): The fracture toughness of ice in contact with salt water. *J. Glaciol.*, **35**, 191–192.
- SCHULSON, E.M., HOXIE, S.G. and NIXON, W.A. (1989a): The tensile strength of cracked ice. *Philos. Mag.*, **A59**, 303–311.
- SCHULSON, E.M., GIES, M.C., LASONDE, G.L. and NIXON, W.A. (1989b): The effect of the specimen-plate interface on internal cracking and brittle fracture of ice under compression: high-speed photography. *J. Glaciol.*, **35**, 378–382.
- TIMCO, G.W. and FREDERKING, R.M.W. (1982): Comparative strengths of fresh water ice. *Cold Reg. Sci. Technol.*, **6**, 21–27.
- ZAGORODNOV, V.S. (1988): Recent Soviet activities on ice core drilling and core investigations in Arctic region. *Bull. Glacier Res.*, **6**, 81–84.
- ZAGORODNOV, V.S. (1989): Antifreeze-thermodrilling of cores in Arctic sheet glaciers. *Ice Core Drilling: Proceedings of the Third International Workshop on Ice Drilling Technology, Grenoble, France, Oct. 10–14, 1988*, ed. by C. RADO and D. BEAUDOING. Grenoble, Centre National de la Recherche Scientifique, Laboratoire de Glaciologie et Geophysique de l'Environnement, 97–109.
- ZAGORODNOV, V.S. and ARKHIPOV, S. (1990): Studies of structure, composition and temperature regime of sheet glaciers of Svalbard and Severnaya Zemlya: methods and outcomes. *Bull. Glacier Res.*, **8**, 19–28.
- ZAGORODNOV, V.S., KELLEY, J.J., KOCI, B., STANFORD, K.L. and COLLINS, J. (1992): Directional drilling. *Polar Ice Coring Office. University of Alaska Fairbanks, Tech. Rep.*, **92-5**, 17 p.
- ZAGORODNOV, V.S., MOREV, V.A., NAGORNOV, O.V., KELLEY, J.J., GOSINK, T.A., and KOCI, B. (1993): Hydrophilic liquid in glacier boreholes. *Cold Reg. Sci. Technol.* (in press).
- ZOTIKOV, I.A. (1979): Antifreeze-thermodrilling for core through the central part of the Ross Ice Shelf (J-9 Camp), Antarctica. *CRREL Rep.*, **79-24**, 12 p.

(Received April 20, 1993; Revised manuscript received October 12, 1993)